



Tuzio® Savoy Towel Warmer Installation Guide

**Code: E1091 / E1093 / E1097
29.5" x 66.5" Electric Plug-In**

**Technical Helpline:
Toll-Free 1-877-757-8990
www.icocanada.com**



**3005 Saskatchewan Drive
Regina, SK | S4T 1H5**

**toll-free | 1 877 757 8930
tel | 306 757 8941 fax | 306 757 8940**

Towel Warmer Installation Procedure

① Rough-in Requirements (see figure 3)

1. A 110V receptacle located no further than 18" from electric plug-in exit location on towel warmer (see fig. 2), and not above electric plug-in exit location.
2. Wall studs or plywood backing is required in the wall at all bracket locations. See figure 2 for bracket locations.

② Installation Instructions (see figure 1)

1. Check all items have been received. You should have Towel Warmer and mounting bracket kit. Read all instructions before continuing.
2. Fix wall supports "A" to the wall using the screws provided and in locations as shown on figure 2.
3. Assemble the threaded pin "B", the washer "C", the bush "D" with the threaded head "E", between the second and third upper and lower tubes of the Towel Warmer.
4. Hang and adjust the Towel Warmer using set screws "F" to lock pin "B" in the wall bracket "A". Ensure the Towel Warmer is firmly and safely fixed.

fig. 1

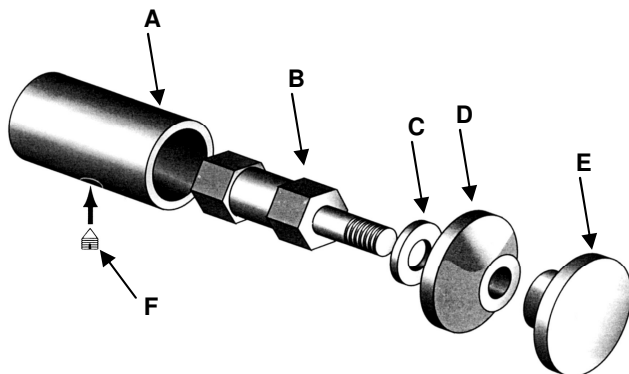

③ Electric Plug-In Connection

Do not connect the Towel Warmer to the power supply until all instructions have been read and installation carried out in accord with them. The heating element is 450W 110V. The element conforms to UL standards and the unit to CSA standards (File ref: 229718). Ensure the CSA label is visible.

1. Turn off power supply.
2. Plug connector in.
3. Switch on power supply again.

Warning: In case of damage or failure of the Towel Warmer the unit should be returned to the manufacturer or their distributor. The warranty of 1 year on the heating element and 5 years on the Towel Warmer is NOT VALID in case of improper use or installation. Product is designed for use within Canada and the United States only.

Specifications & Drawings



Model #	Description	Finish	Weight (lb)	Element Size	Output	WxH (mm)	WxH (Inches)	Metal Type
E1091	Savoy Electric Plug-In	White	72.0	450W	5234Btu	750 x 1690	29.5" x 66.5"	Mild Steel
E1093	Savoy Electric Plug-In	Chrome	72.0	450W	5234Btu	750 x 1690	29.5" x 66.5"	Mild Steel
E1097	Savoy Electric Plug-In	Oil-Rubbed Bronze	72.0	450W	5234Btu	750 x 1690	29.5" x 66.5"	Mild Steel

Heating Element Specifications: 600 watt, 29.5" long, 120 volt, 60 Htz, IP55 cord, ULC approved. Includes 4ft cord and factory fitted plug.

Material Specifications: Mild Steel - Din 2394 Quality - ST 34-2 KB

Warranty: Towel Warmer: 5 years, Heating Element: 1 year

Fixings: Screws, and Allen Key (if needed) are included

Heating Element Location: Right-hand vertical column unless specified otherwise.

Care & Maintenance: A periodic wash using warm water and a soft cloth will retain the high quality finish of your towel warmer for many years to come. ON NO ACCOUNT should any household bleaches, detergents, abrasive polishes, steel wool or other cleaning agents be used on this item.

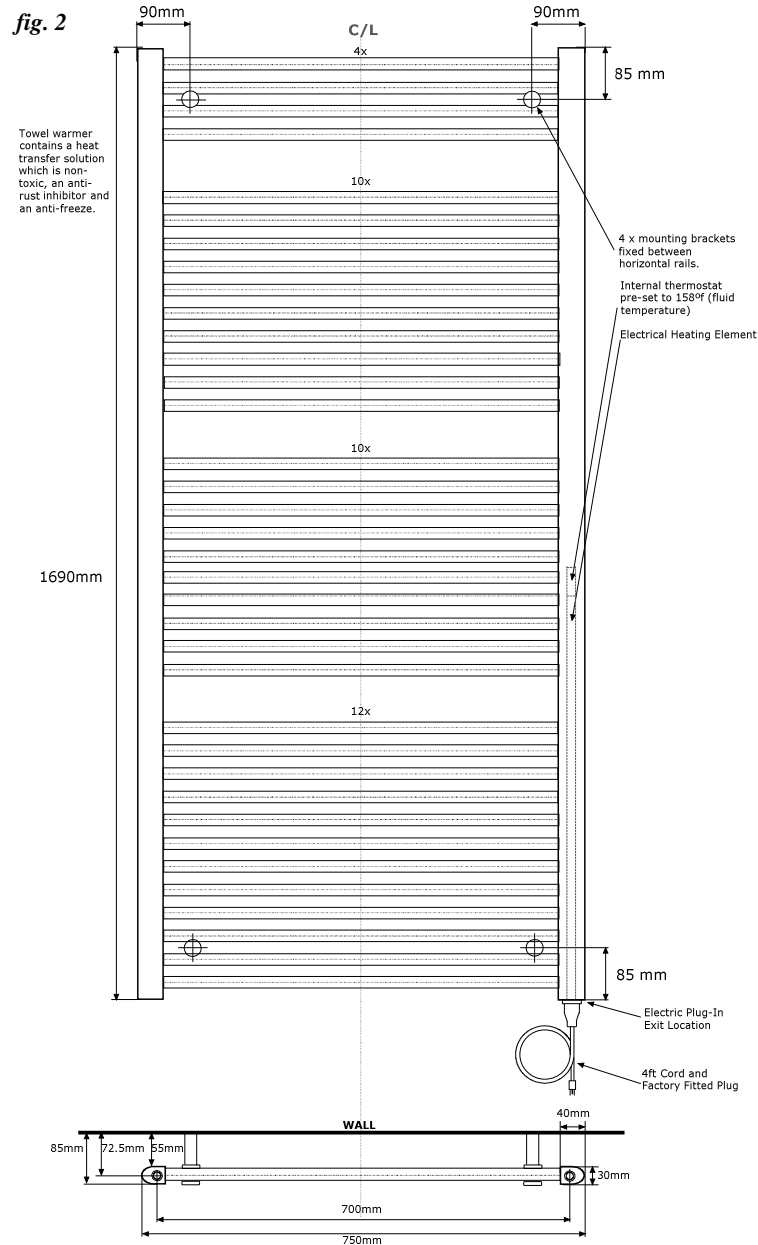



Towel Warmers



Electric In-Floor Heating



Insulation Board



Bathroom Luxury

info@icocanada.com
www.icocanada.com

toll-free | 1 877 757 8930
tel | 306 757 8941 fax | 306 757 8940

3005 Saskatchewan Drive
Regina, SK | Canada | S4T 1H5